

FILL IN SHADED AREAS TO COMPLETE THE PART DESCRIPTION

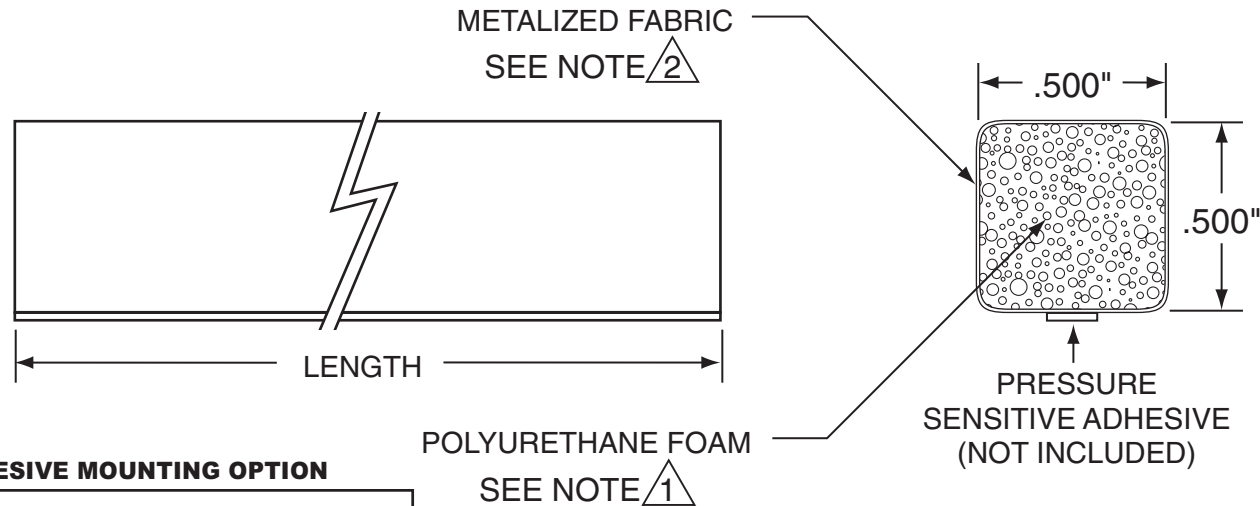

SELECT ADHESIVE MOUNTING OPTION

WITH PRESSURE SENSITIVE ADHESIVE.
WITHOUT PRESSURE SENSITIVE ADHESIVE.

FILL IN LENGTH IN INCHES BELOW

Fill in length to two decimals (LL.LL). Maximum 84.00 inches.

TECH-ETCH MANUFACTURING PART NUMBER

2421 - 101 - 0120 -
(PROFILE) - (LENGTH)

NOTES:

- ① OPEN-CELLED POLYURETHANE FOAM CORE.
- ② NICKEL PLATING OVER COPPER SUBSTRATE FABRIC.
- 3. COMPRESSION SET (ASTM D3574) 2.6%.
- 4. FLAMMABILITY RATING UL 94 V-RATED.
- 5. COMPRESSION DEFLECTION (ASTM D3574) 1.47 PSI.
- 6. SURFACE RESISTIVITY (ASTM F390) <.02 OHMS.
- 7. SERVICE TEMPERATURE -40°F TO 1J1 °F (-40°C TO J0°C).
- 8. UNLESS OTHERWISE SPECIFIED DIMENSIONS ARE IN INCHES.

UNLESS OTHERWISE SPECIFIED ALL TOLERANCES TO BE:
HEIGHT & WIDTH
<.100 ±.02
>.100 ±.03
LENGTH
1 TO 6 ±.03
6 TO 11 ±.05
11 TO 24 ±.15
24+ +1/-.25

Tech-Etch

45 Aldrin Road, Plymouth, MA 02360
TEL 508-747-0300 • FAX 508-746-9639
sales@tech-etch.com • www.tech-etch.com

SCALE:
200%

CATALOG PROFILE:
2421 - 101 - 0120

DATE:
11/15/03

PART NAME:
Square Metalized Fabric Gasket

CUSTOMER PART NUMBER: